

Part Number: PT278-35071

NOTE: Part number of this accessory may not be the same as the part number shown.

Kit Contents

| Item # | Quantity Req'd. | Description |
|--------|-----------------|---------------------|
| 1 | 1 | Air Dam / Light Bar |

Hardware Bag 1 Contents

| Item # | Quantity Req'd. | Description |
|--------|-----------------|-------------------------------|
| 1 | 2 | Screw, M6x33mm, Wafer Head |
| 2 | 2 | Screw, M6x27.83mm, Wafer Head |
| 3 | 1 | T25 Tamper Resistant Torx Bit |

Hardware Bag 2 Contents

| Item # | Quantity Req'd. | Description |
|--------|-----------------|--------------------|
| 1 | 1 | Relay |
| 2 | 1 | 15A Fuse |
| 3 | 1 | Switch |
| 4 | 5 | 7" Tie Wrap |
| 5 | 2 | Foam Tape |
| 6 | 1 | Car Care Guide |
| 7 | 1 | Protective Plug |
| 8 | 1 | Instruction Sheets |
| 9 | 1 | Vinyl Tubing |
| 10 | 1 | Fender Washer |
| 11 | 1 | Paper Washer |
| 12 | 1 | Plastic Connector |

Hardware Bag 3 Contents

| Item # | Quantity Req'd. | Description |
|--------|-----------------|------------------------|
| 1 | 1 | Connector/Wire Harness |
| 2 | 1 | Rubber O-Ring |
| 3 | 2 | Jam Nuts |

Additional Items Required For Installation

| Item # | Quantity Req'd. | Description |
|--------|-----------------|-------------|
| 1 | | |

Conflicts

| |
|------|
| None |
|------|

Recommended Tools

| Personal & Vehicle Protection | Notes |
|-------------------------------|--|
| Safety Goggles | |
| Vehicle Protection | |
| MaskingTape | |
| Special Tools | Notes |
| Torque wrench (3) | 10-50 lbf-in. 40-200 fbf-in. 5-75 lbf-ft |
| Debur tool | |
| Shop Vacuum | |

| Installation Tools | Notes |
|-------------------------------|-------|
| 10mm Socket | |
| 17mm Flare Nut Socket | |
| Panel Removal Tool | |
| Drill | |
| 3/16" Drill Bit | |
| 14mm Taper Drill Bit | |
| Side Cutters | |
| Drill Template | |
| 17 mm Open End Wrench | |
| T25 Tamper Resistant Torx Bit | |
| 12 mm Box wrench | |
| Special Chemicals | Notes |
| 3M Prep Sol-70 | |
| 3M Ultrapro Body Sealant | |

General Applicability

| |
|--|
| |
|--|

Recommended Sequence of Application





| Item # | Accessory |
|--------|---------------------|
| 1 | Roof Rack |
| 2 | Off Road Lights |
| 3 | Auxiliary Lights |
| 4 | TVIP |
| 5 | Portable Navigation |

*Mandatory

Vehicle Service Parts (may be required for reassembly)

| Item # | Quantity Req'd. | Description |
|--------|-----------------|-------------|
| 1 | | |
| 2 | | |
| 3 | | |

Legend

| | |
|---|--|
|  | STOP: Damage to the vehicle may occur. Do not proceed until process has been complied with. |
|  | OPERATOR SAFETY: Use caution to avoid risk of injury. |
|  | CAUTION: A process that must be carefully observed in order to reduce the risk of damage to the accessory/vehicle and to ensure a quality installation. |
|  | TOOLS & EQUIPMENT: Used in Figures calls out the specific tools and equipment recommended for this process. |

Care must be taken when installing this accessory to ensure damage does not occur to the vehicle. The installation of this accessory should follow approved guidelines to ensure a quality installation.

These guidelines can be found in the "Accessory Installation Practices" document.



This document covers such items as:-

- Vehicle Protection (use of covers and blankets, cleaning chemicals, etc.).
- Safety (eye protection, rechecking torque procedure, etc.).
- Vehicle Disassembly/Reassembly (panel removal, part storage, etc.).
- Electrical Component Disassembly/Reassembly (battery disconnection, connector removal, etc.).

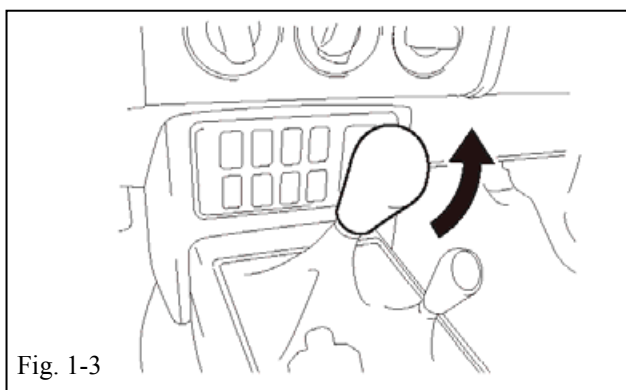
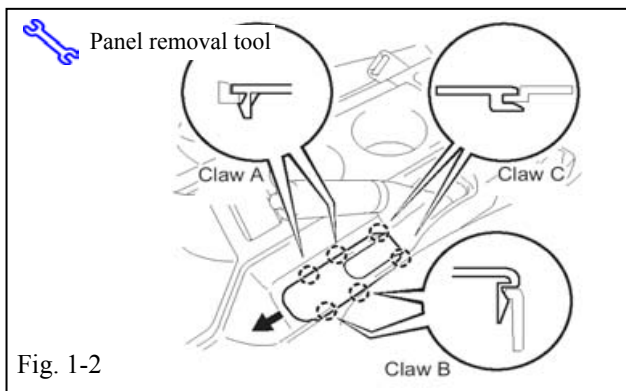
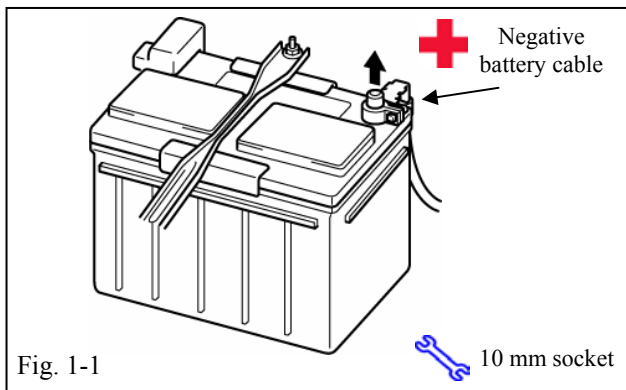
Please see your Toyota dealer for a copy of this document.



1. Vehicle Disassembly

- (a) Set parking brake.
 - (b) Remove the negative battery cable (Fig. 1-1).
 -  (1) Protect the fender before starting.
 -  (2) Do not touch the positive terminal with any tool when removing cable.
 - (c) Wait 90 seconds before proceeding to disassemble vehicle.
- NOTE:** Place all removed parts on a protected surface.
- NOTE:** When disconnecting wiring connectors, do not pull on the wiring. Pull on the connector only.
- (d) Remove the parking brake cover plate. (Fig 1-2).
 - (e) Shift the lever into the N position. (Fig. 1-3)
 - (f) Remove the shift lever knob and 4x4 shift knob. (Fig. 1-3)

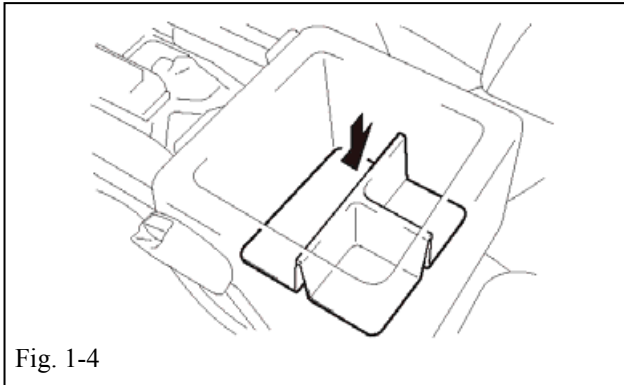

Fig. 1-4

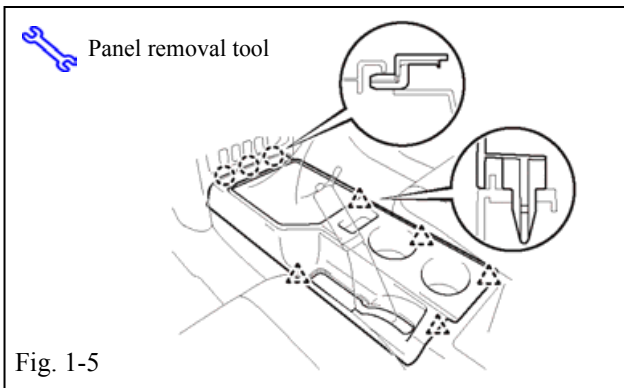

Fig. 1-5

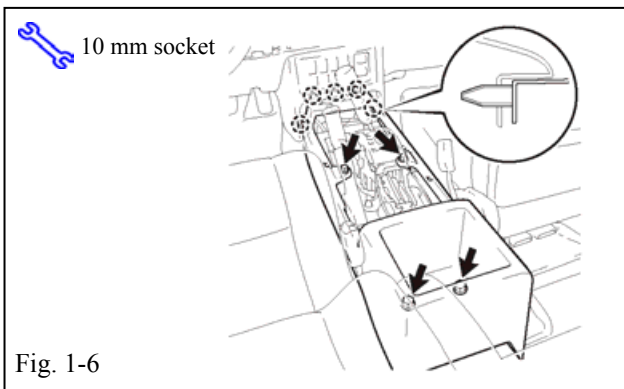

Fig. 1-6

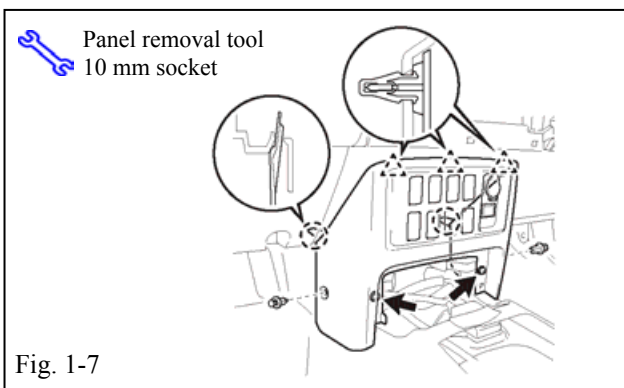

Fig. 1-7

(g) Remove the box bottom mat. (Fig. 1-4)

(h) Disengage and remove the top portion of the center console. (Fig. 1-5)



(i) Reattach shift lever knobs.



NOTE: Reattaching knobs will prevent scratching center console.

(j) Remove the four (4) screws. (Fig. 1-6)

(k) Carefully disengage the console assembly and position rearward.



(l) Cover front portion of console with cloth.

(m) Remove the lower instrument console assembly. (Fig. 1-7)

(1) Remove the two (2) clips and two (2) screws.

(2) Disengage the three (3) clips and two (2) claws and tilt the instrument console rearward to allow access to remove knockout.

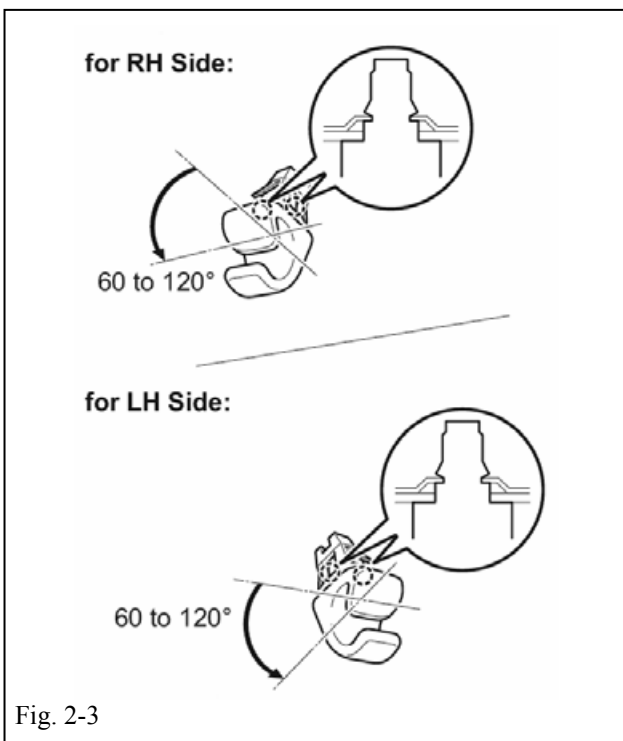
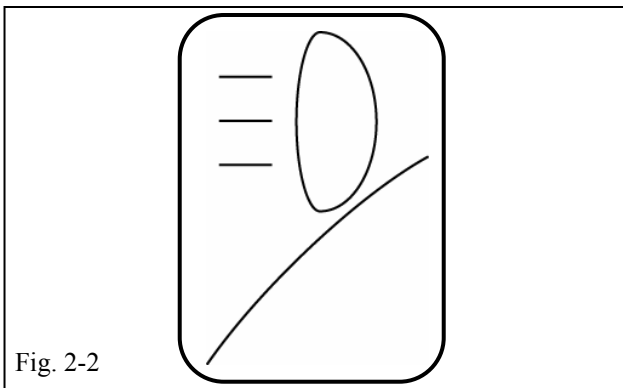
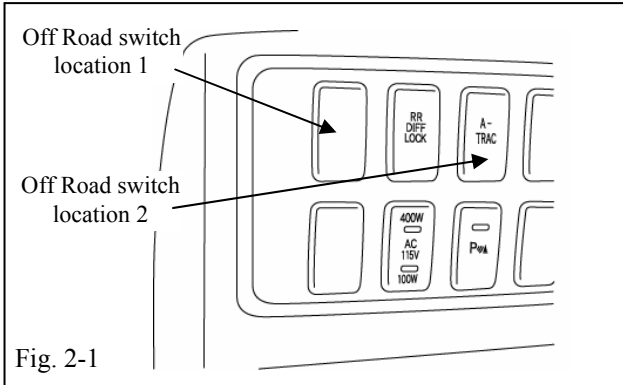

2. Interior Installation of Switch/Wire Harness

- (a) Locate the vehicle white 6-pin connector behind the lower instrument panel. (Fig. 2-1)
 - (1) Note: The vehicle connector will be wrapped in gray foam tape.
- (b) Install the Off Road switch (Fig. 2-2) in the available knockout (Location 1 or 2) and in the orientation shown. (Fig. 2-1)
- (c) Plug the white 6-pin connector into the switch.
 - (1) Confirm the connector is securely attached.
- (d) Remove driver and passenger side sun visors.
 - (1) Rotate and loosen the visor support shaft from the visor holder clips as shown. (Fig. 2-3)
 -  (2) Do not remove clips from headliner.

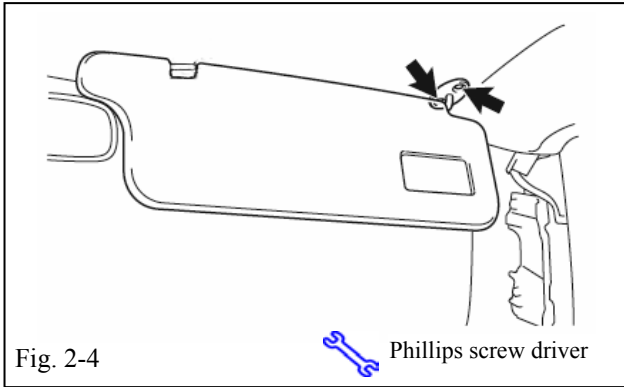

- (e) Remove sun visors (Fig. 2-4)
 - (1) Remove the two (2) Phillips screws from driver and passenger side sun visors.

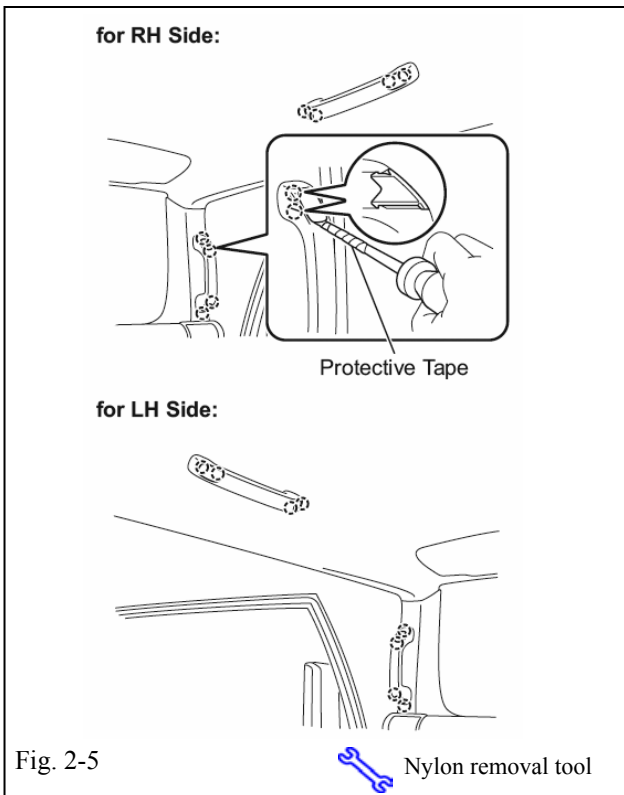

- (f) Remove the driver and passenger side assist grips.
 - (1) Carefully remove the screw covers for all four (4) assist grips. (Fig. 2-5)

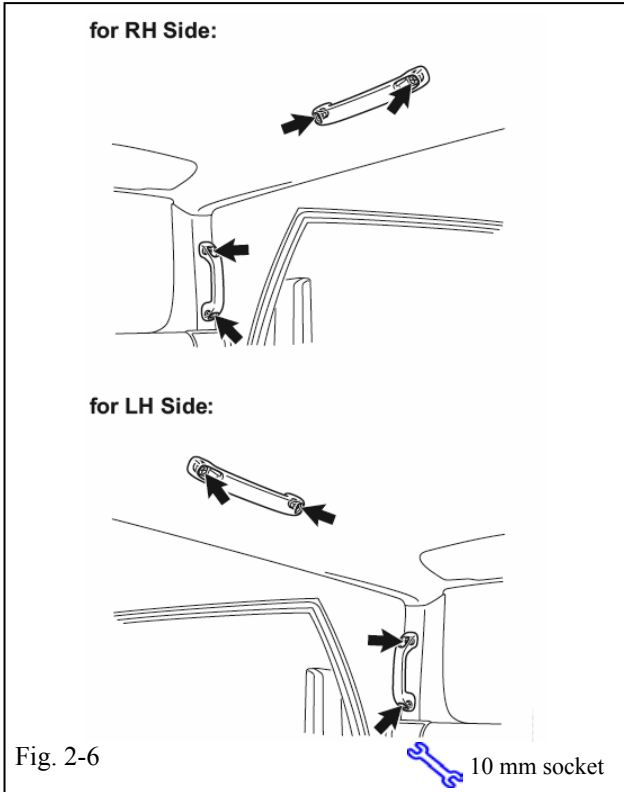

- (g) Remove the two (2) 10 mm hex head screws from driver and passenger side assist grips. (Fig. 2-6)

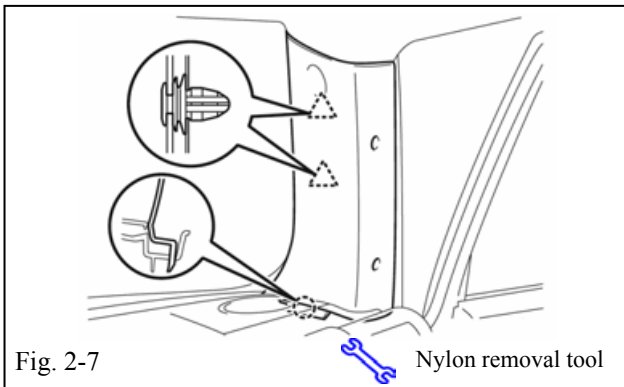

- (h) Remove front passenger side "A" pillar garnish.
 - (1) Pull door seal down from around front pillar.
 - (2) Disengage two (2) clips and one (1) claw and remove the front pillar garnish. (Fig. 2-7)

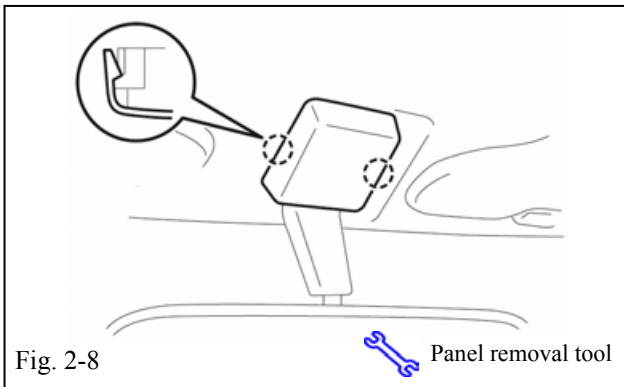

- (i) Remove front pillar garnish driver side.
 - (1) Use the same procedure as for the passenger side.
- (j) Remove the rear view mirror.
 - (1) Remove the mirror base mount cover by carefully inserting panel removal tool as shown. (Fig. 2-8)

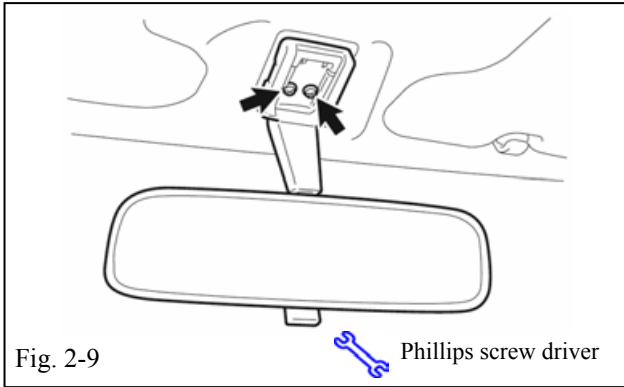

- (2) Remove the two (2) Phillips screws. (Fig. 2-9)

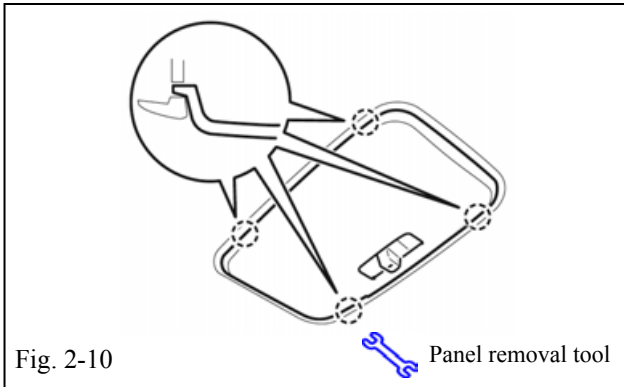

- (k) Remove the dome light lens cover using panel removal tool to disengage the four (4) claws. (Fig. 2-10)

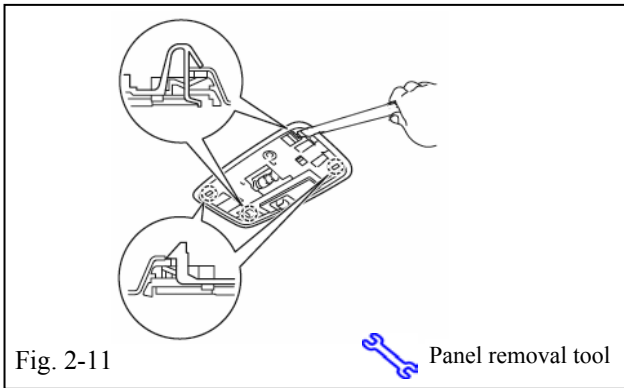

- (l) Using panel removal tool, disengage the four (4) claws and lower the dome light. (Fig. 2-11)



- (1) Do not remove dome light from its wire harness.

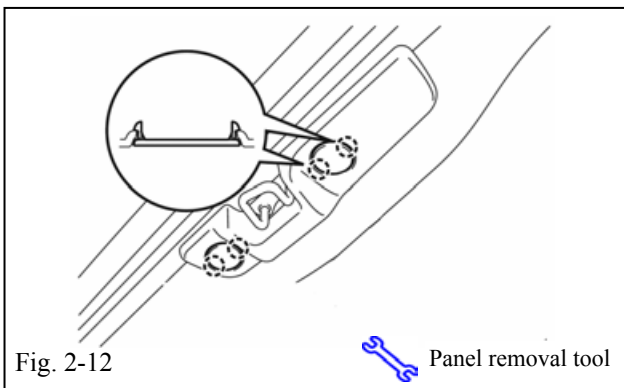

- (m) Remove door latch garnish.
 - (1) With panel removal tool, carefully remove the two (2) plastic covers on the driver and passenger side door latches. (Fig. 2-12)

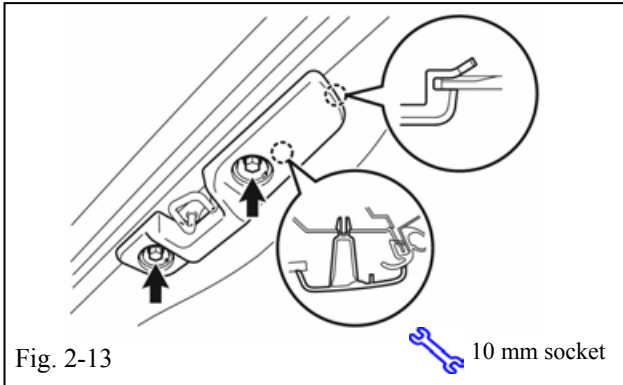

(2) Remove the two (2) 10 mm hex screws and remove the door latch garnish from driver and passenger side. (Fig. 2-13)

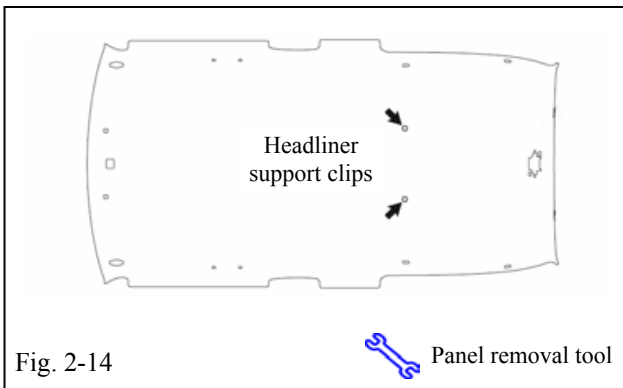

(n) With panel removal tool, carefully remove the two (2) headliner support clips. (Fig. 2-14)

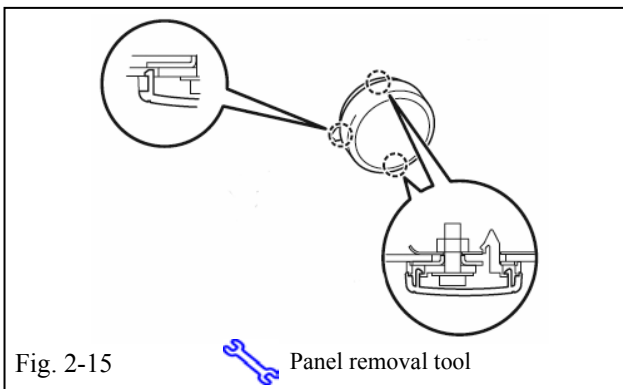

(o) Remove driver side headliner hole plug.
(1) With panel removal tool, disengage the three (3) claws and open the cover. (Fig. 2-15)

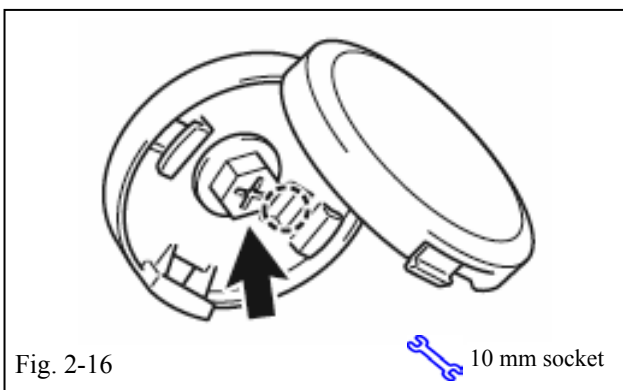

(2) Remove the 10 mm hex screw and disengage the claw. Remove the headliner hole plug. (Fig. 2-16)
(3) Repeat process for passenger side headliner hole plug.

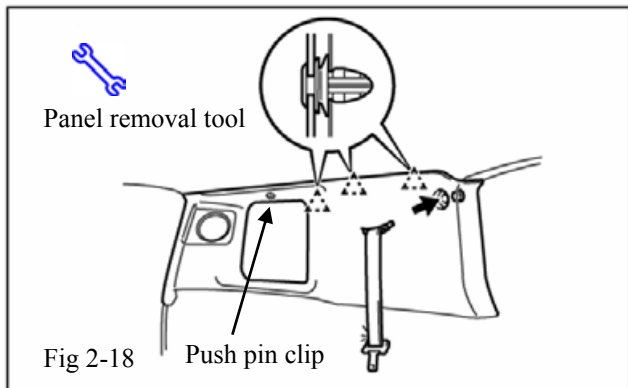
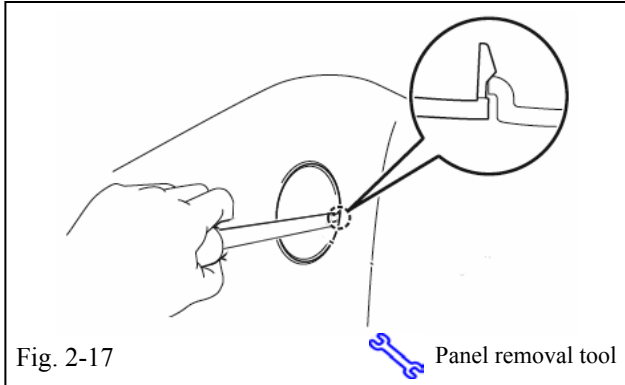

- (p) Disengage upper driver side quarter trim panel.
 - (1) With panel removal tool, disengage the claw and open the cover. (Fig. 2-17)

- (2) Remove the push pin clip. (Fig. 2-18)
 - (3) Remove the 10 mm hex screw and disengage the three (3) clips.
 - (4) Pull the panel out slightly to allow the head liner to drop freely.



- (5) Use a foam block to keep panel in place to prevent scratching the headliner with panel.

- (q) Pull top portion of the weather door seal away to allow the headliner to drop.
- (r) Repeat the process for passenger side.





- (s) Carefully lower the driver and passenger side front portion of the headliner.

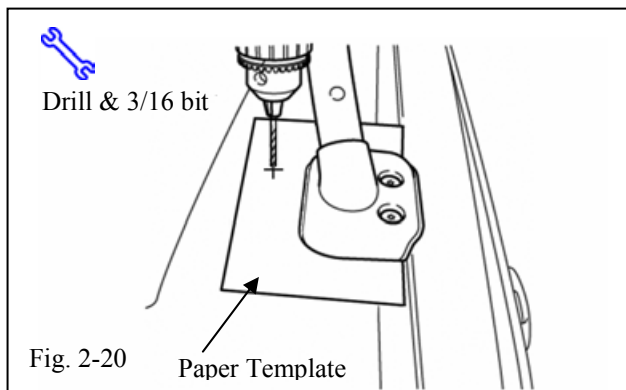
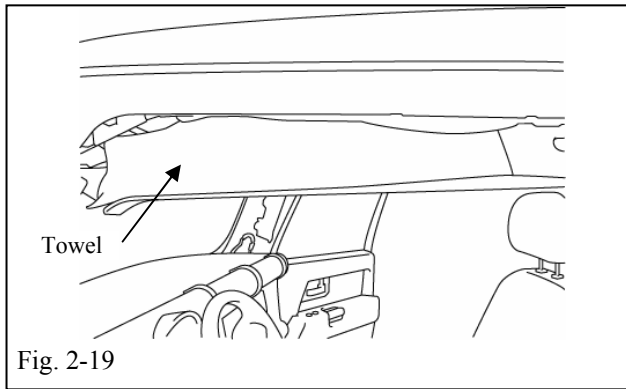

- (1) Take care not to cause a crease in the headliner while installing the interior wire harness.



- (t) Installation of roof wire harness.
 - (1) Place towel under front portion of headliner to catch metal shavings. (Fig. 2-19)
 -  (2) Clean roof panel around the roof rack foot pad with 3M™ Prep Sol-70. (Fig. 2-20)
 -  (a) Apply the paper masking tape to roof panel around roof rack foot pad.
 - (b) Locate the template onto the roof and drill the pilot hole.
 - (i) Drill a pilot hole with 3/16" drill
 - (c) Remove the template and masking tape from roof.

NOTE: Paper template is last page of instruction

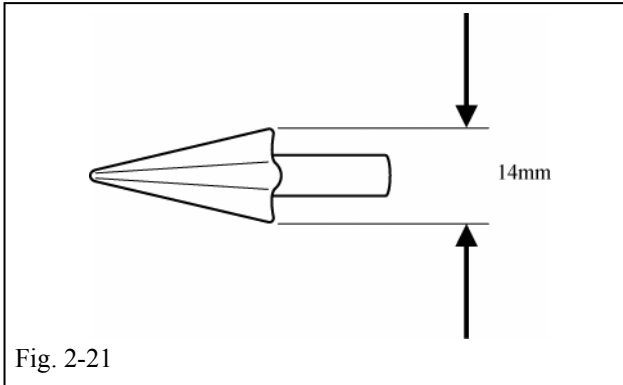

- (3) ⚠ Using a 14 mm (9/16") taper drill bit, carefully drill a hole in roof to the 14 mm hole size. (Fig. 2-21 and Fig. 2-22)

STOP **Caution:** Do not use standard twist drill bit. It will cause damage to the thin wall roof sheet metal. The taper drill bit is designed to make clean hole in thin metal.

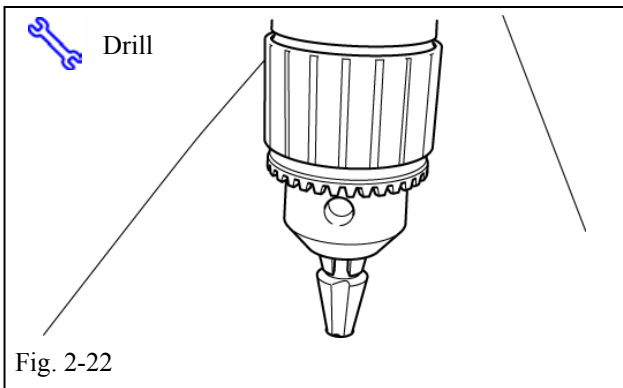

- (4) ⚠ Debur top and bottom surface of the hole. (Fig. 2-23)

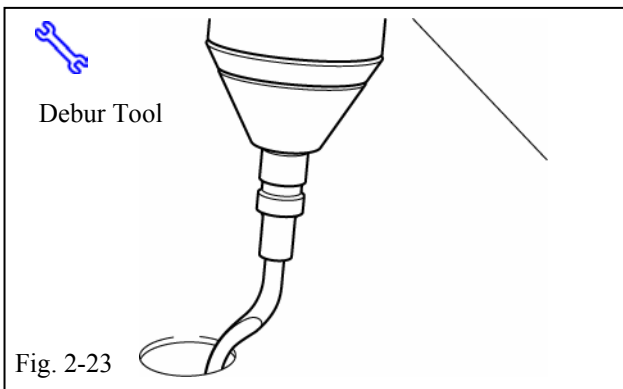

- (5) Vacuum all metal shavings from top of vehicle.
- (6) Remove the towel from the headliner.
- (7) Vacuum any metal shavings from the top side of the headliner.

- (8) ⚠ Install the O-Ring onto the connector. (Fig. 2-24)

STOP (i) Make sure the O-Ring is properly seated in the connector.

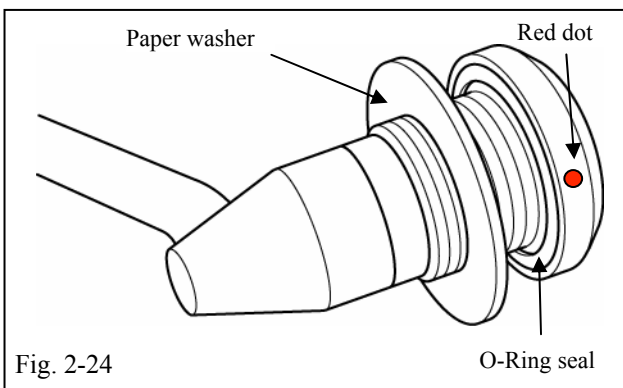

- (9) ⚠ Install paper washer onto the threaded portion of the socket connector. (Fig. 2-24)

- (u) From the exterior of the vehicle, feed the green and black wires with the terminals into the newly drilled roof hole.

(v) Apply a 1/8" sealant bead of 3M Body Sealant completely around the hole as shown.

 (w) Carefully install the connector-washer assembly onto the roof, making sure the paper washer is sealed to the roof by the 3M Sealant.

(x) From the interior of the vehicle, feed the large fender washer onto both green and black wires until it reaches the threaded portion of the connector.

(y) Feed one of the jam nuts over green and black wires and hand tighten the jam nut and washer onto the connector.

 (1) The fender washer must be flush against the roof.

 (z) Position the connector so the red dot on the connector is facing straight rearwards.

 (aa) Hold the top portion of the connector with a 17 mm open end wrench and tighten the jam nut with a 17 mm torque wrench to 27 lbf-in. (3 N-m).

 (24lbf-in to 30lbf-in).

(1) Feed the second jam nut over the green and black wires and tighten it to 27 lbf-inch.

 (2) Use the 17 mm open end wrench to hold the first jam nut.

 (bb) Install the vinyl tubing supplied in the kit over the green and black wires.

(cc) The completed connector installation should be as shown. (Fig. 2-26)

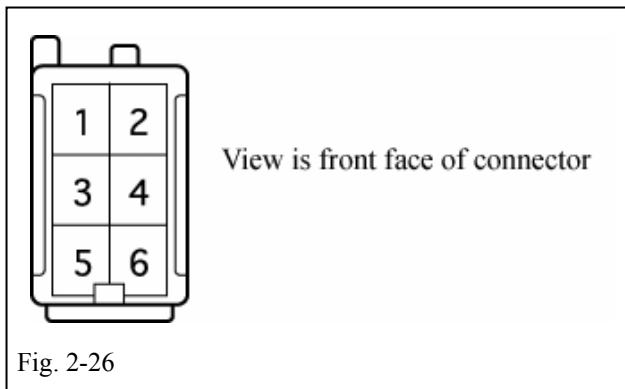
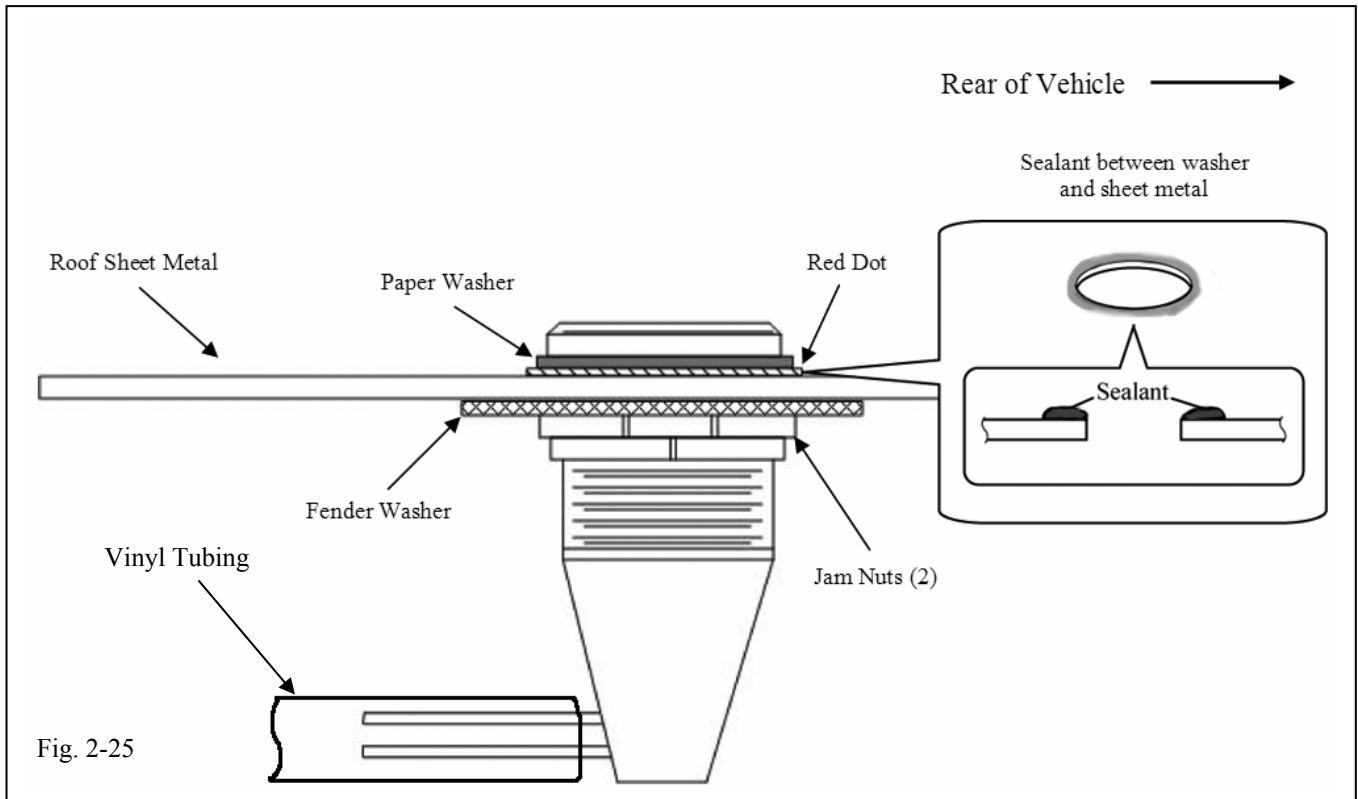

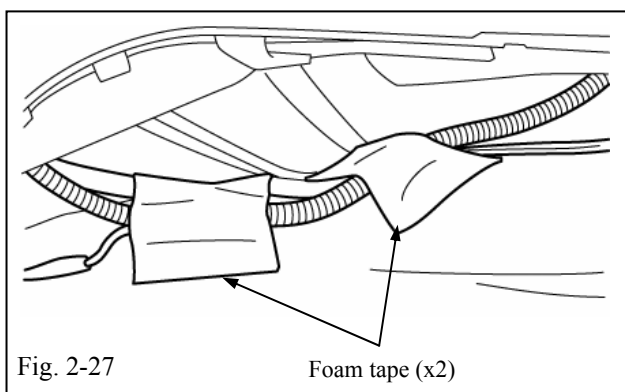

(dd) Install connector onto accessory wire harness. (Fig. 2-26)

- (1) Insert the connector pin with the green wire into location 5 of connector.
- (2) Insert the connector pin with the black wire into location 6 of connector.



(ee) Cut off one inch of foam tape from long side from one of the foam tapes and put aside to be used later in figure 2-29.

(ff) Route the accessory wire harness along side the vehicle wire harness on the headliner and secure it to the headliner as shown with two foam tapes. (Fig. 2-27)

-  (1) Be sure that wire harness is routed above and over air bag harness if applicable.
-  (2) Do not wire tie the accessory wire harness to air bag harness if applicable.
-  (3) To support the headliner during the rest of the installation process, secure the headliner by reinstalling the two sun visor clips.

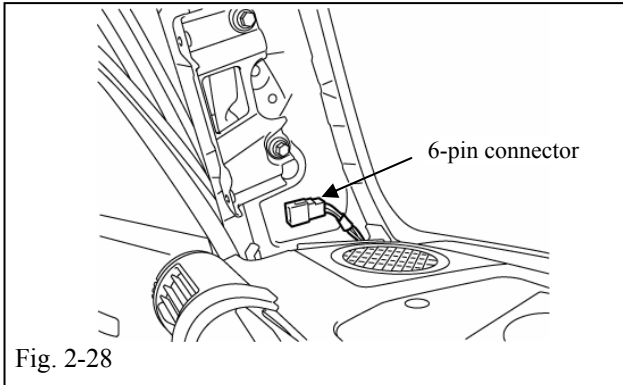

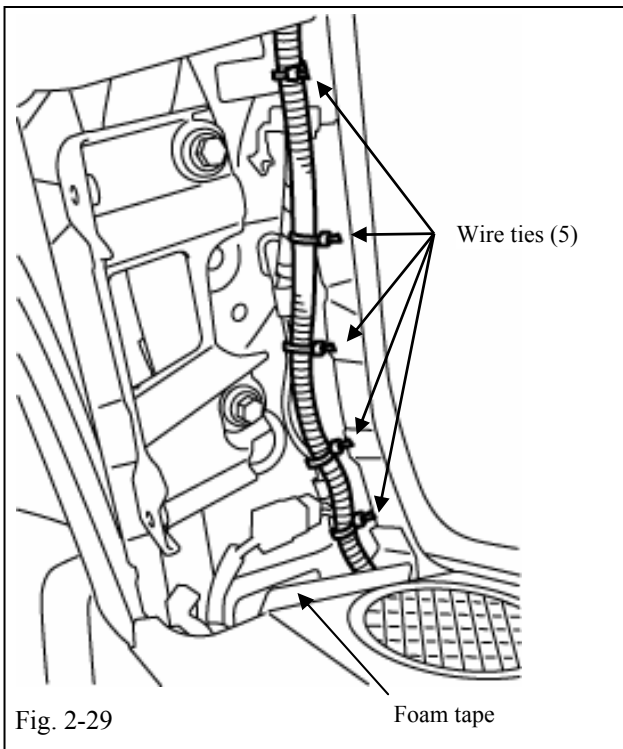

- (gg) Locate the white six pin connector on the driver side "A" pillar.
 - (1) Plug the accessory wire harness connector into the vehicle connector on the A pillar. (Fig. 2-28)

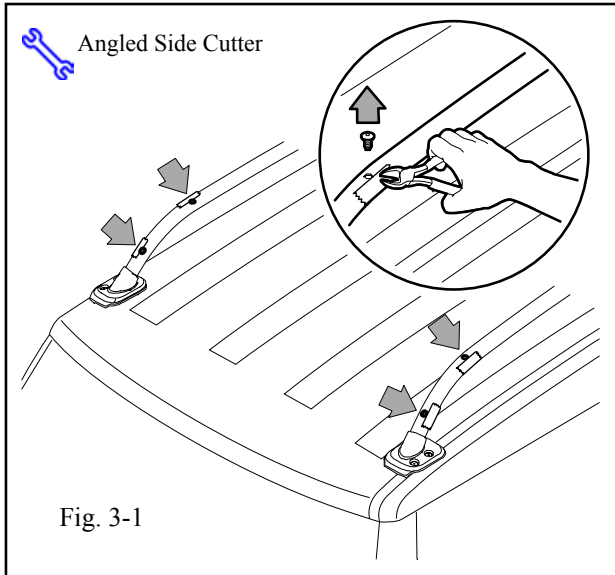

- (hh) Route the accessory wire harness down the A pillar next to the vehicle wire harness.
 - (1) Secure the wire harness with five (5) wire ties and the one inch foam tape as shown. (Fig. 2-29)
 - (2) Cut excess from wire ties.



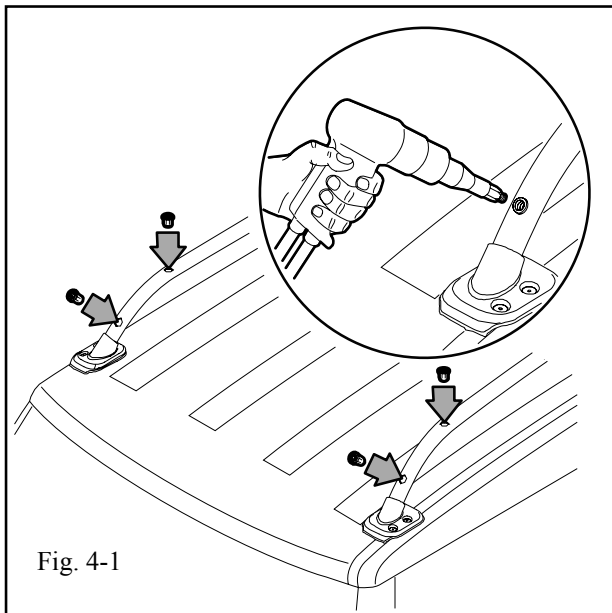

3. Remove Plugs. (4 locations)

-  (a) Place masking tape on rails to protect from side cutter tool. (Fig. 3-1)
-  (b) Use angled side cutter to remove plugs from their holes. (Fig. 3-1)
-  (c) Remove masking tape.
- (d) Note: Some roof racks may have the soft rubber plugs and can be removed by hand and steps 3a-3c are not required.



4. Install Rivnuts. (4 locations)

-  (a) Insert the 6M rivnuts into holes on rail. (Fig. 4-1)
-  (b) Tighten rivnuts using rivnut tool.

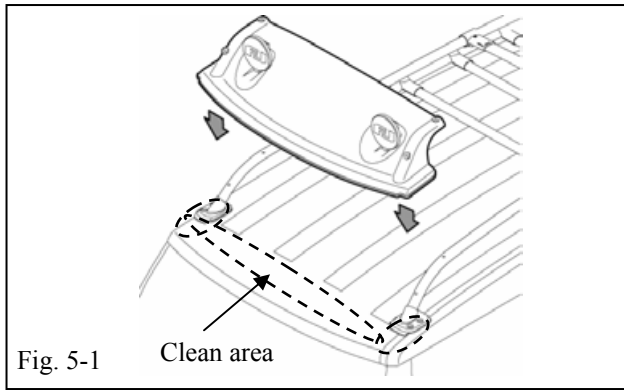

5. Position Air Dam / Light Bar.

- ⚠ (a) Clean roof surface area with 3M™ Prep Sol-70 prior to installing air dam. (Fig. 5-1)
- (b) Carefully position the air dam/light bar on the roof rack assembly. Line up holes in air dam/light bar with the holes on the roof rack. (See Fig. 5-1 for position)

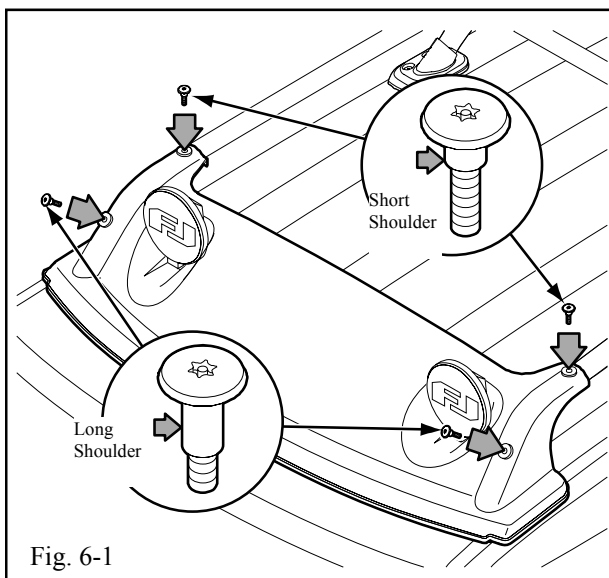

6. Install Screws.

- ⚠ (a) Hand start both the front (long shoulder) screws first. (Fig. 6-1)
- (b) Hand start both the rear (short shoulder) screws. (Fig. 6-1)

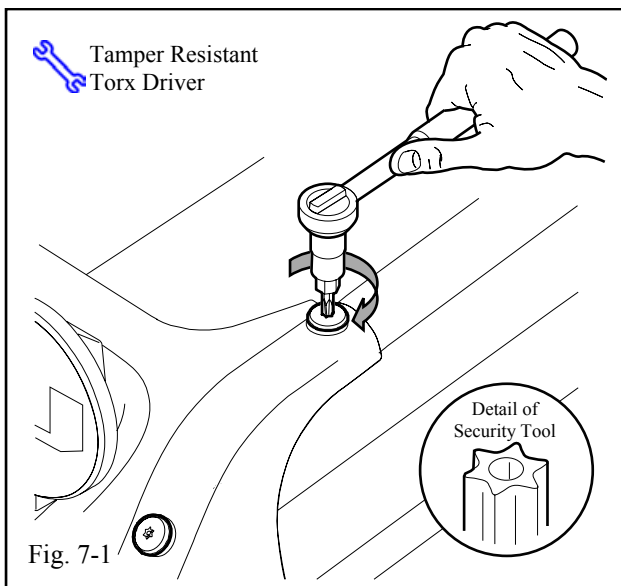

7. Secure Air Dam/Light Bar.

- ⚠ (a) Using the tamper resistant Torx driver and torque wrench, tighten all four screws to 88.5 lbf-in (10.0 N-m). (Fig. 7-1)

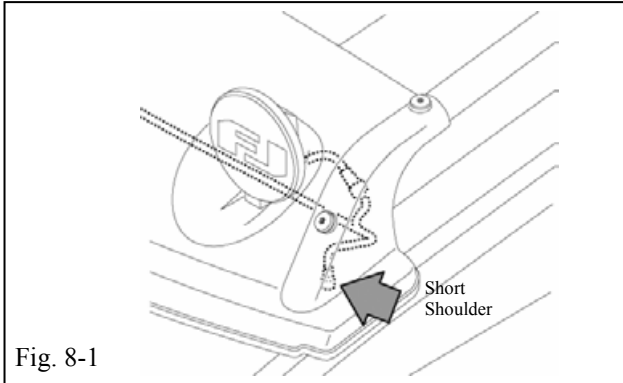

8. Connect Wiring Harness

-  (a) Align the plug connector key with the socket key and connect wiring harness to vehicle roof connector. (Fig. 8-1)
 - (1) Note: Connector is keyed.
- (b) Make sure that the wire harness is routed between the air dam and the bracket and not to the outside of air dam bracket.

9. In Process Function Check

(a) Install the provided relay and fuse in the locations shown in the engine room R/B.

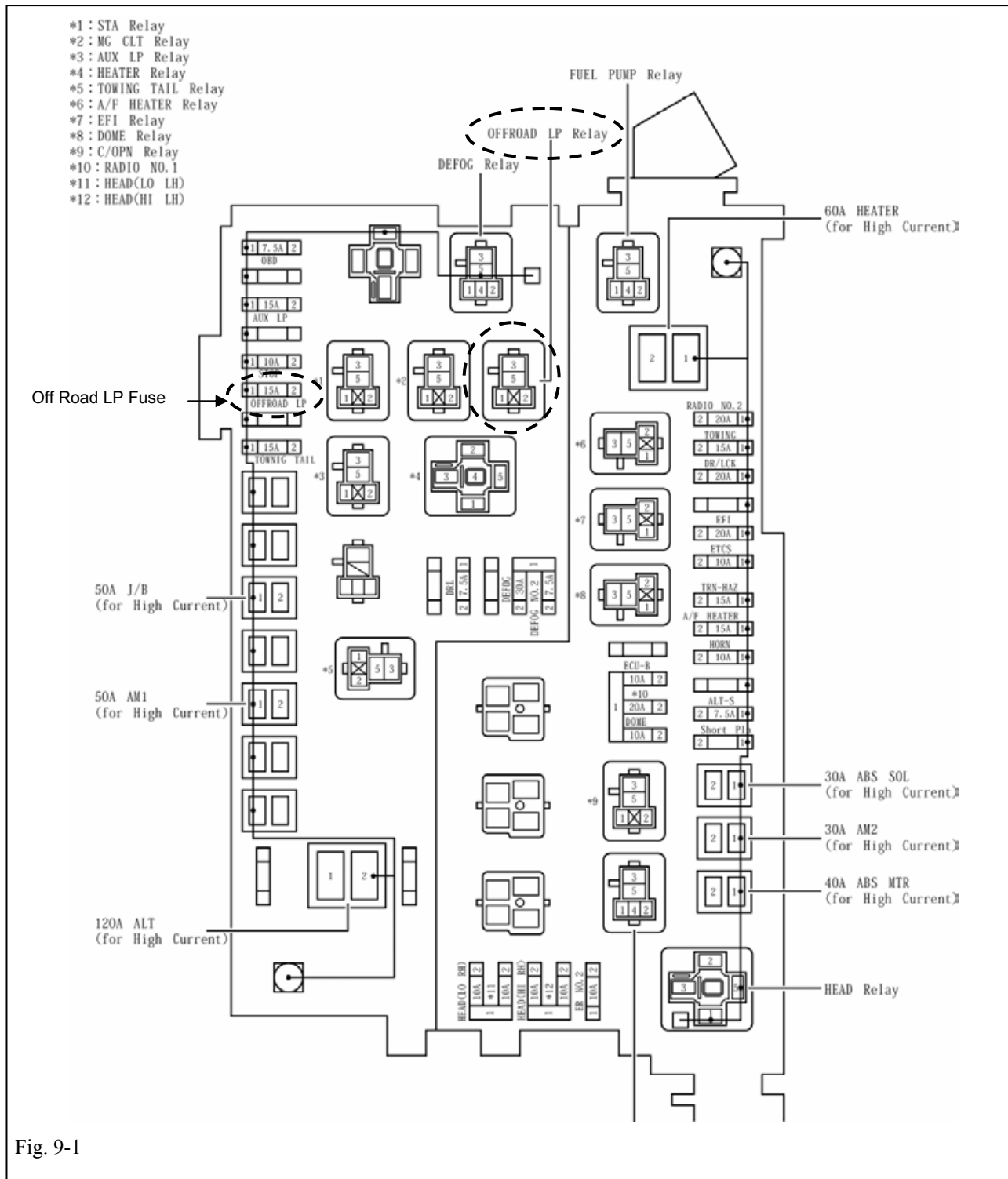
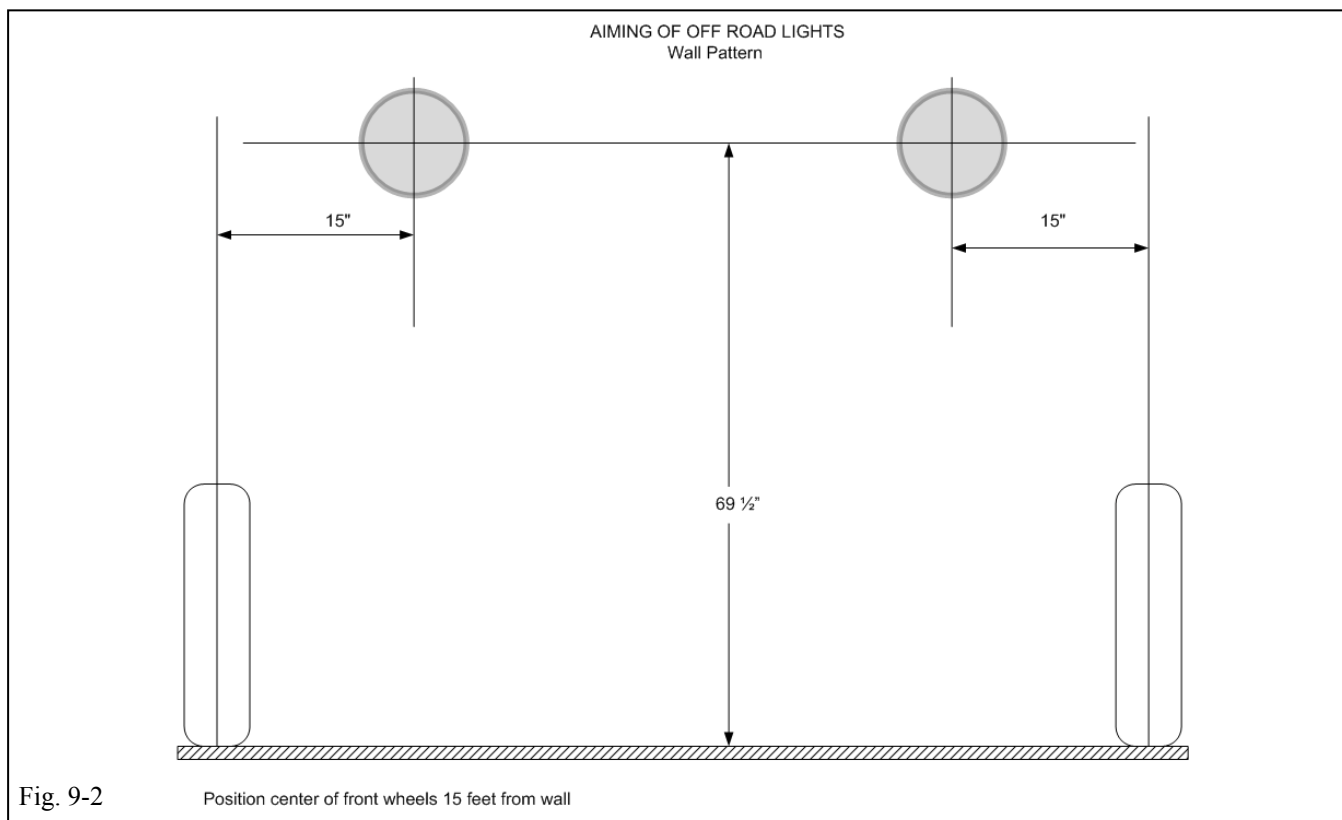

Fig. 9-1

- (b) Reconnect the negative terminal battery.
 - (1) Tighten the nut with 4.1 N·m (36 lbf-in) of torque
 - (2) Remove the lamp covers.
 - (3) Turn the ignition key to IG position.
 - (4) Turn on the head lamps.
 - (5) Press the Off Road light switch in and out and confirm that the Off Road lights turn on and off.
 - (6) Confirm that the green indicator lamp is on when the Off Road lights are on.
 - (7) Confirm that the switch illumination back light is on.

- (8) Confirm that light aiming pattern is correct. (Fig. 9-2)
- (9) If necessary, adjust lamps using a 12 mm wrench and tighten to 15 lbf-ft (14 lbf-ft to 16lbf-ft).

NOTE: Remove rubber plug at rear of air dam to access the 12mm hex head nut.



10. Disconnect the negative terminal of the battery

11. Reassembly of Vehicle

- (a) Reassemble the vehicle.
- (b) Verify the panels fit together properly with no uneven gaps between them.
- (c) Verify the headliner for proper fit and alignment.
- (d) Place the kit supplied Torx wrench inside the plastic bag with the Care Guide.
- (e) Place Care Guide bag with connector plug in glove box.



- (f) Reattach the lamp covers to lamps.
- (g) Air bag scan tool check.
 - (1) Connect the scan tool connector to the vehicle's diagnostic connector in the lower dash area.
 - (i) Turn ignition switch to ON position.
 - (ii) Check for Airbag ECU trouble codes – if present then clear the DTCs.
 - (iii) Refer to hand held scan tool tester operator's manual for further details.



NOTE: Check for the latest version of the software on Toyota Information System (TIS) before setting up the scan tool.



NOTE: Ensure the software is the latest version (software release 13.3a R028: 1/20/06 or later.)



NOTE: Download the latest software from Toyota Information System (TIS).

| <u>Check:</u> | <u>Look For:</u> |
|---|--|
| <p><u>Accessory Function Checks</u></p> <ul style="list-style-type: none"><input type="checkbox"/> Lights function<input type="checkbox"/> Off road light switch indicator<input type="checkbox"/> Auxiliary switch back light | <p>Only turns on with headlights on</p> <p>Indicator lamp is on when off road lights are on.</p> <p>Switch back light turns on</p> |
| <p><u>Vehicle Function Checks</u></p> <ul style="list-style-type: none"><input type="checkbox"/> Check functions of all switch functions on center IP console<input type="checkbox"/> Confirm torque range of air dam for all four bolts, 84lbf-in to 93 lbf-in. | |

Cut along dotted line

Center punch for pilot
hole location

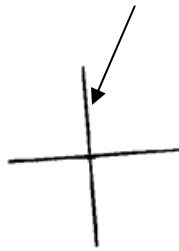

6.3"
(160 mm)

