



**Technical Service  
BULLETIN**

November 16, 2001

Title:

**REPAIR MANUAL SUPPLEMENT:  
VEHICLE PULLING TO ONE SIDE**

Models:

**All '02 – '07 Toyota & '04 – '07 Scion Models**

**STEERING**  
**ST005-01**  
**REVISED**

**TSB REVISION NOTICE:**

- **April 4, 2006:** 2007 model year has been added to Applicable Vehicles.
  - **October 21, 2005:** 2003 – 2006 model years for Toyota models and 2004 – 2006 model years for Scion models have been added to Applicable Vehicles. A note has been added to the illustration in Repair Procedure 3.
  - **March 1, 2004:** The note in Step 2-A of the “Wheel Alignment & Tire Characteristics” Section has been changed.
  - **December 21, 2001:** OP Codes updated in Warranty Information.
- All previous versions of this TSB should be discarded.**

**Introduction** This bulletin contains general vehicle pulling diagnosis and repair procedures along with specific information to help correct pulling complaints.

This information supplements Repair Manual procedures when the symptoms are:

- The driver holds the steering wheel without exerting steering effort while driving straight ahead, the vehicle drifts to the right or the left.
- While driving straight ahead, the driver has to steer either to the right or the left to maintain straight driving.

**Applicable Vehicles**

- **2002 – 2007** model year **Toyota** vehicles.
- **2004 – 2007** model year **Scion** vehicles.

**Warranty Information**

OP CODE	DESCRIPTION	TIME	OFF	T1	T2
ST1005	Preliminary Check & Road Test	0.6	45046-09020	31	99
Combo A	Switch Front Tire/Wheel & Road Test	0.5			
Combo B	Reverse the Front One Side Tire	0.7			
Combo C	Check Front Wheel Alignment	1.2			
Combo D	Adjust Front Wheel Alignment	0.7			
420091	Dismount and Mount Tire and Balance Wheel and Tire Assembly	0.5	42611-08010		
Combo A	Each additional Wheel	0.3			

**NOTE:**

**Above combination codes A, B, D and E include road test time.**

**Applicable Warranty\*:**

**This repair is covered under the Toyota Comprehensive Warranty. This warranty is in effect for 12 months or 20,000 miles, whichever occurs first, from the vehicle's in-service date.**

\* Warranty application is limited to correction of a problem based upon a customer's specific complaint.



**Contents** This bulletin is divided into the following sections:

**Wheel Alignment and Tire Characteristics** ..... **Pages 3–4**

**Repair Procedure Flow Chart** ..... **Page 5**

**Repair Procedures**

- 1. **Important Notice** ..... **Page 6**
- 2. **Troubleshooting** ..... **Pages 6–7**
- 3. **Vehicle Pulling Caused by Wheel Alignment** ..... **Pages 7–8**
- 4. **Vehicle Pulling Caused by Tire Conicity** ..... **Pages 8–10**
- 5. **Camber Adjustment Method** ..... **Pages 10–11**

**Wheel Alignment & Tire Characteristics**

**1. Relationship Between Wheel Alignment and Vehicle Pulling to One Side**

When the cross camber or caster of the front wheel alignment is large, it can cause vehicle pulling.

WHEEL ALIGNMENT	DIRECTION OF VEHICLE PULLING
Camber	Vehicle pulls in direction of wheel with large camber value
Caster	Vehicle pulls in direction of wheel with small caster value

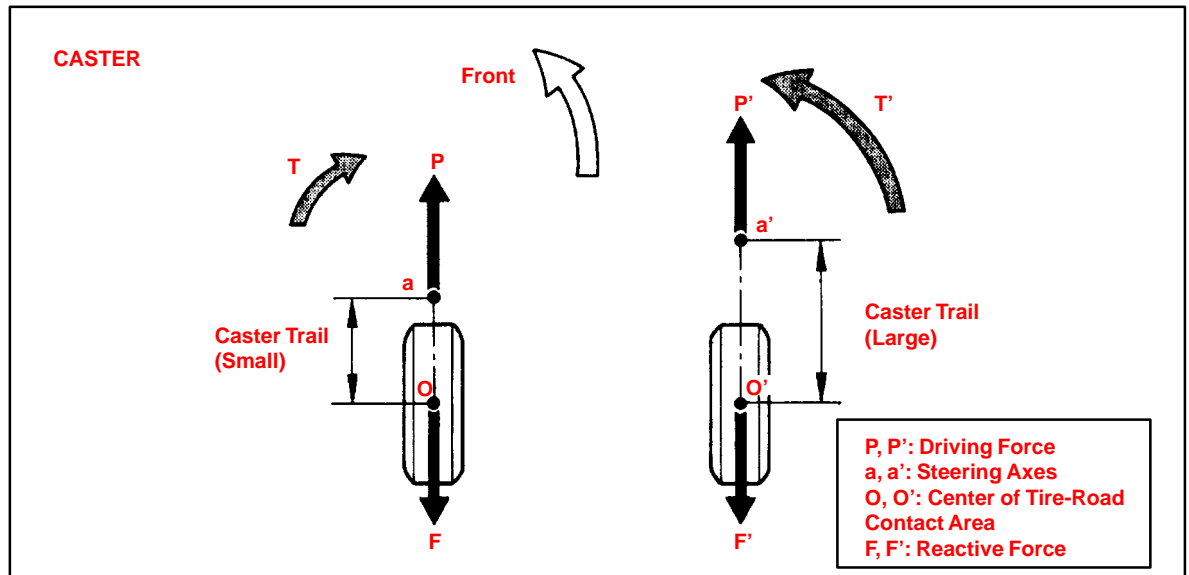
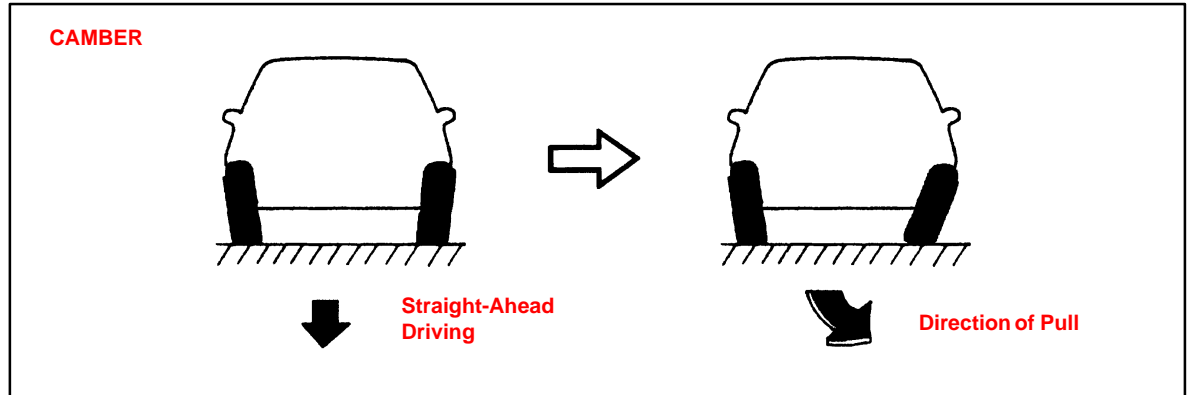

If the cross camber or caster is within the specified range (30' or less), noticeable vehicle pulling will not occur due to side-to-side differences in camber or caster.

**NOTE:**

On a flat road, if the cross camber or caster is 30' or less and the steering wheel is held without exerting steering effort for 100 m (109 yards) when driving at 100 km/h (62 mph), the alignment-induced drift distance is approximately 0.5 m (1.64 ft).

**Wheel Alignment & Tire Characteristics**  
(Continued)

## 2. Relationship Between Tire Characteristics and Vehicle Pulling to One Side

When radial tires are rotating, they have the characteristic of generating force in the lateral direction between the tire and the road surface. This lateral force is comprised of two factors:

- Ply-steer, which changes direction according to the rotation direction of the tires.
- Conicity, which is generated in a fixed direction regardless of the tire rotation direction.

If these lateral forces are too strong, vehicle pulling will occur.

### A. Ply-Steer

Lateral force due to ply-steer is produced by the construction of the belts inside the tire tread. With radial tires, the wire of the belt is slanted as shown in the illustration below. Thus, it is in the lateral direction that tire tread easily changes shape (stretches), and lateral force is generated between the tire and the road surface in the lateral direction.

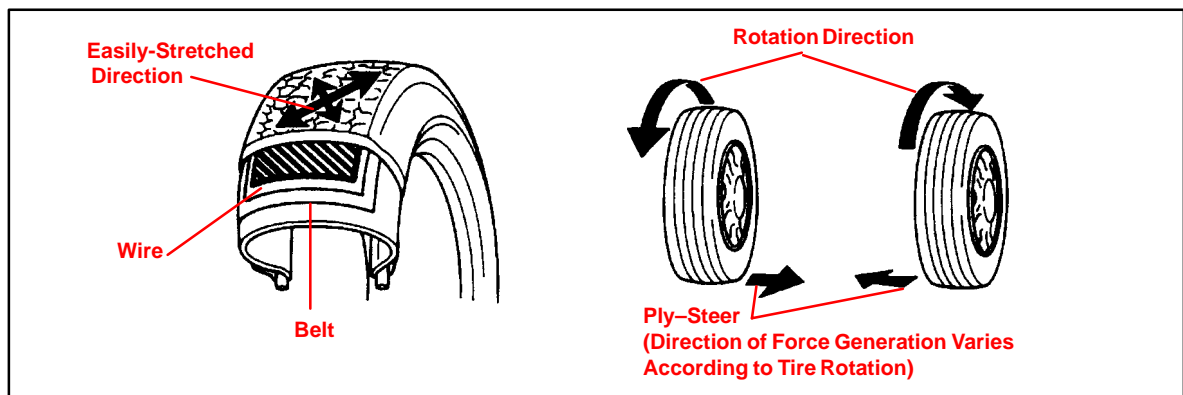

#### NOTE:

Lateral force from ply-steer prevents vehicle drift caused by road slant, so in many cases lateral force to the left is provided to compensate for road slant to the right.

### B. Conicity

Conicity is lateral force resulting from uneven formation of the left and right sides of the tire. The direction the lateral force is exerted depends on the hardness of the side walls and the difference in height between the left/right sides of the tire.

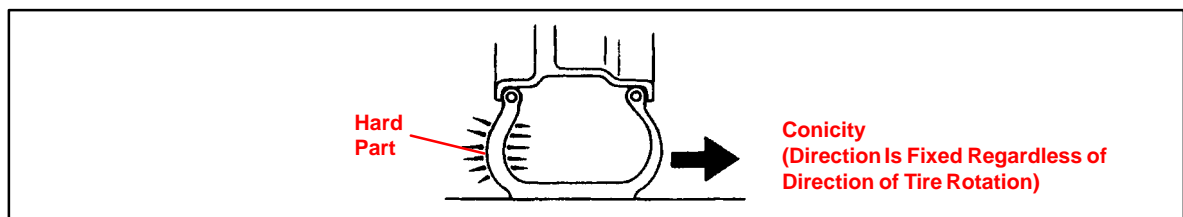

#### NOTE:

- In the case of vehicle pulling caused by tires, the lateral force which is exerted as a result of conicity has the greatest effect. On a flat road, if the steering wheel is held without exerting steering effort for 100 m (109 yards) when travelling at 100 km/h (62 mph), the vehicle may drift as much as 1.5 m (5 ft).
- When vehicle pulling is due to conicity, the amount of drift can be reduced and the direction of drift can be changed by changing the location of the tire or reversing the tire when installing it on the wheel.

Repair Procedure Flow Chart

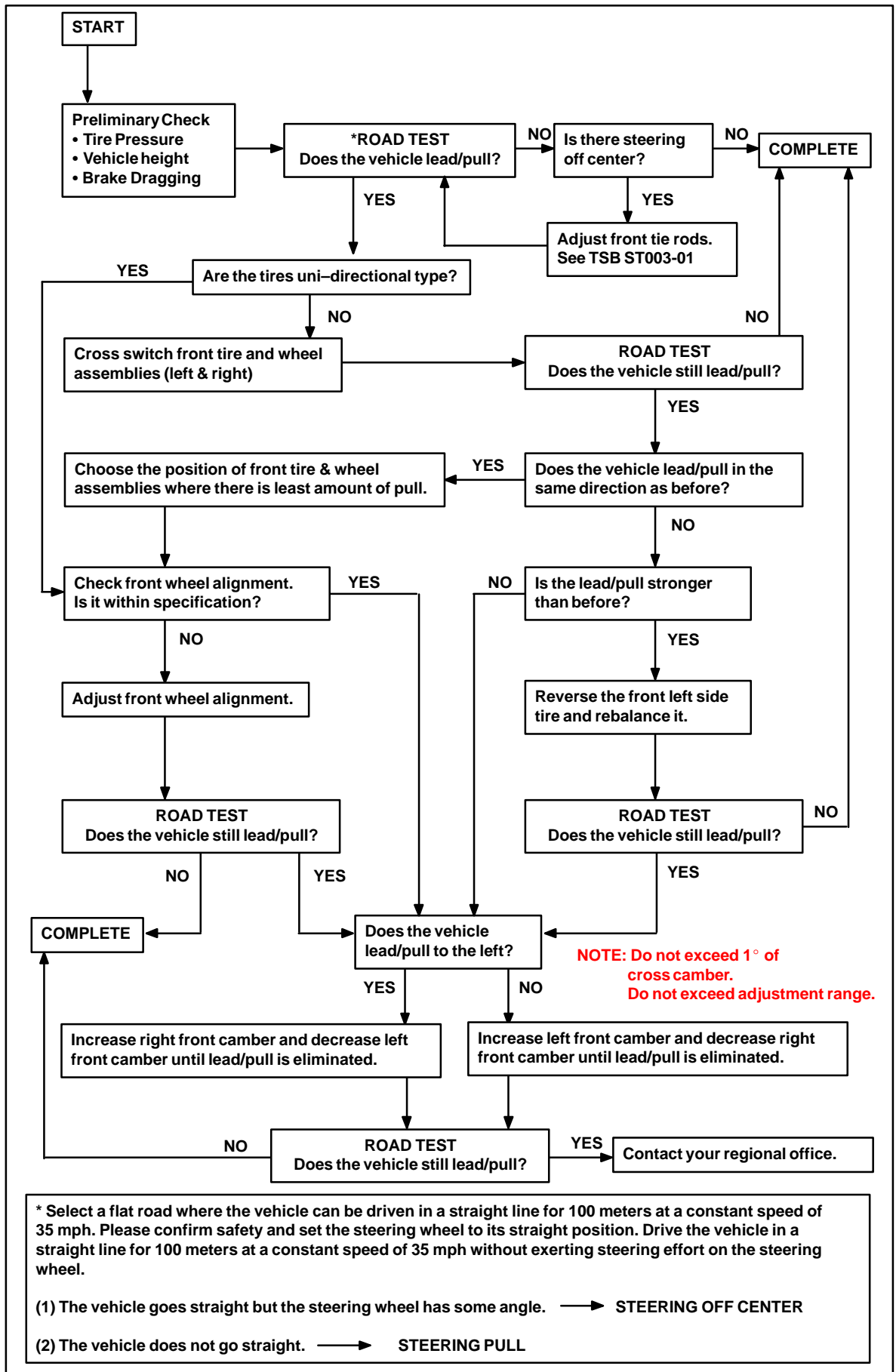

**Repair  
Procedures**

**1. IMPORTANT NOTICE**

Before repairing vehicle pulling to one side, it is necessary to clearly identify the cause of the pulling condition. Frequently, the cause of the vehicle pulling to one side is diagnosed as wheel alignment. However, the actual cause may be lateral force generated by the tires. Performing wheel alignment when tire force is the cause could result in the wheel alignment being set at a value outside of specifications. This would then cause other problems such as uneven tire wear, etc.

**2. Troubleshooting**

First determine whether vehicle pulling to one side is caused by a wheel alignment problem or tire characteristics, then decide which repairs to make.

**A. Perform the following checks and correct as necessary.**

- a. Check tires for size, wear and for proper inflation pressure.
- b. Check whether the vehicle is noticeably tilted backward/forward or left/right.

**NOTE:**

**Tilting of the vehicle produces a left-right difference in the camber and caster and can cause vehicle pulling to one side.**

- c. Check brakes for dragging.

**B. Confirm problem symptoms.**

With the customer accompanying you, drive the vehicle to confirm if the customer's complaint involves vehicle pulling to one side or steering wheel off center. If the problem is steering wheel off center, adjust the front tie rods on the vehicle. **Refer to Toyota TSB ST003-01.** Also check the direction of vehicle pulling and the extent of the pulling.

**C. Decide if vehicle pulling is due to wheel alignment or tires.**

- a. Switch the left and right front tires (If the tires are non-unidirectional).
- b. Conduct a drive test to check whether the direction that the vehicle pulls has changed.

SYMPTOM	PROBABLE CAUSE	CORRECTIVE ACTION
No change in vehicle pulling condition	Front wheel alignment	Proceed to Repair Procedure 3. Vehicle pulling caused by Wheel Alignment (Page 6)
Vehicle pulling eliminated	Tire conicity	Repair complete. Vehicle Pulling Caused by Tire Conicity (Page 3 and 6)
Vehicle pulling direction is reversed	Tire conicity	Proceed to Repair Procedure 4. Vehicle Pulling Caused by Tire Conicity (Page 7)

**Repair Procedures**  
(Continued)

**Helpful hints to determine cause of vehicle pulling:**

- The direction of lateral force from tire conicity becomes reversed when the left and right tires are switched. Therefore, if the pulling direction changes when the tires are switched, it can be concluded that vehicle pulling is caused by tire conicity.

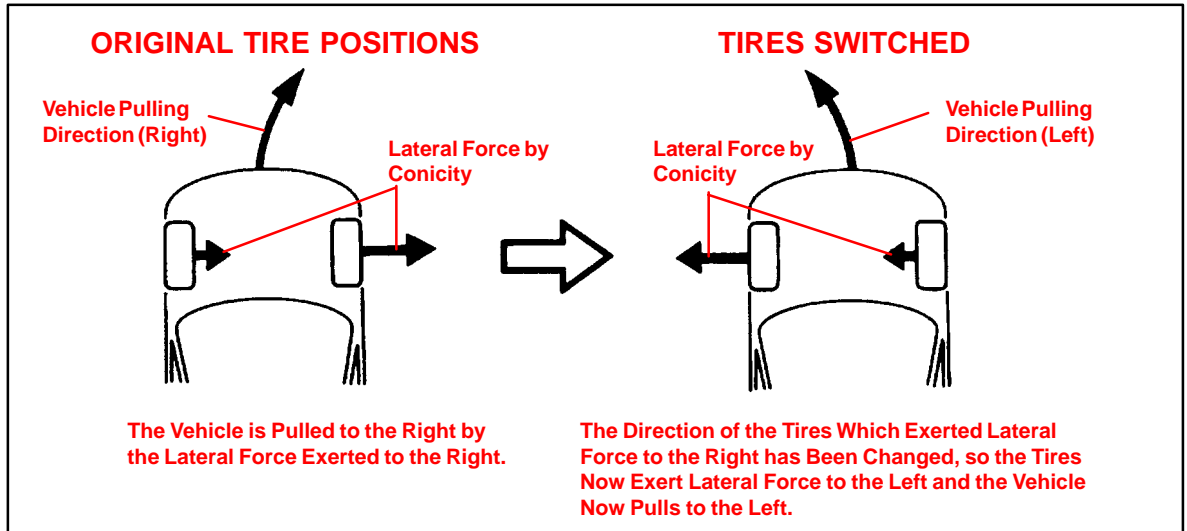

- If the pulling direction does not change after the front tires are switched, the cause of vehicle pulling is not tire conicity. In this case, the likely cause is a front wheel alignment condition.

**3. Vehicle Pulling Caused by Wheel Alignment**

When it is determined by troubleshooting that the vehicle pulling to one side is caused by wheel alignment, perform repairs according to the following procedure.

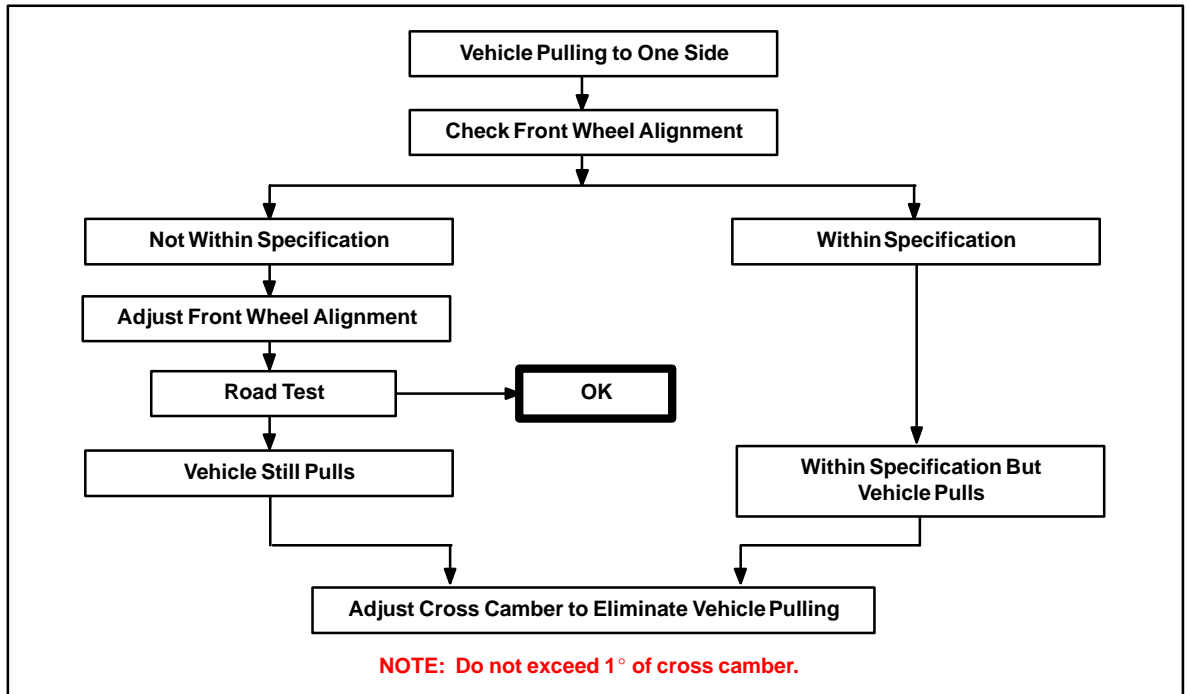

**Repair Procedures**  
(Continued)

WHEN VEHICLE PULLS TO LEFT	WHEN VEHICLE PULLS TO RIGHT
Increase right front camber and decrease left front camber until vehicle pulling is eliminated	Increase left front camber and decrease right front camber until vehicle pulling is eliminated

**NOTE:**

- Keep the cross camber within 1° or less.
- Keep the camber of each wheel within specifications (+/-45' of center value).
- If adjustment exceeds the specifications, uneven tire wear will result.

**4. Vehicle Pulling Caused by Tire Conicity**

When it is determined by troubleshooting that the vehicle pulling to one side is caused by tire conicity, perform repairs according to the following procedures.

**Indication of Tire Conicity as a Cause:**

When the front tires are switched, the pulling direction changes. Proceed to STEP 1.

**STEP 1:**

Remove the front left tire from the wheel and reverse the tire. Then perform a road test and check for change in the pulling direction.

**HINT:**

By performing this operation, it can be checked whether the left or right tire exerts a stronger lateral force. Either tire can be reversed. Shown here is an example of the left tire reversed.

**If Vehicle Pulls in the Same Direction: Go to STEP 2.**

The lateral force generated by the right front tire is greater than the left tire, so the vehicle is pulling due to the lateral force of the right tire.

**ORIGINAL TIRE POSITIONS**

**LEFT TIRE REVERSE INSTALLATION**

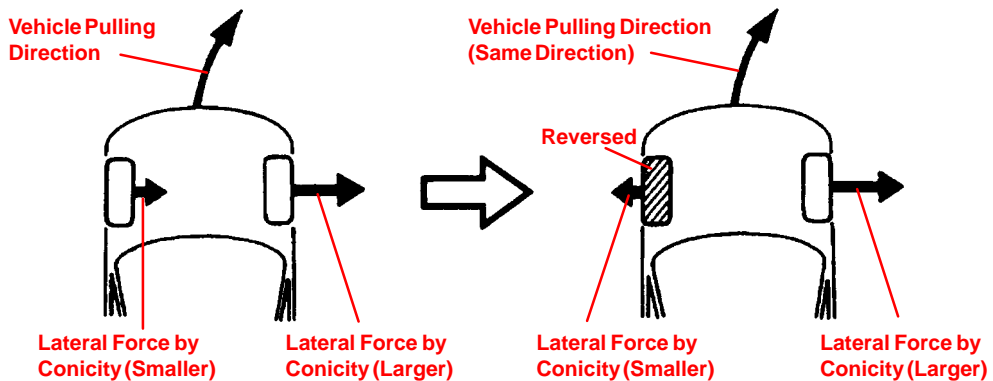



**Repair  
Procedures**  
(Continued)

**If Vehicle Pulls in the Opposite Direction: Go to STEP 2.**

The lateral force generated by the left front tire is greater than the right tire, so the vehicle is pulling due to the lateral force of the left tire.

**ORIGINAL TIRE POSITIONS**

**LEFT TIRE REVERSE INSTALLATION**

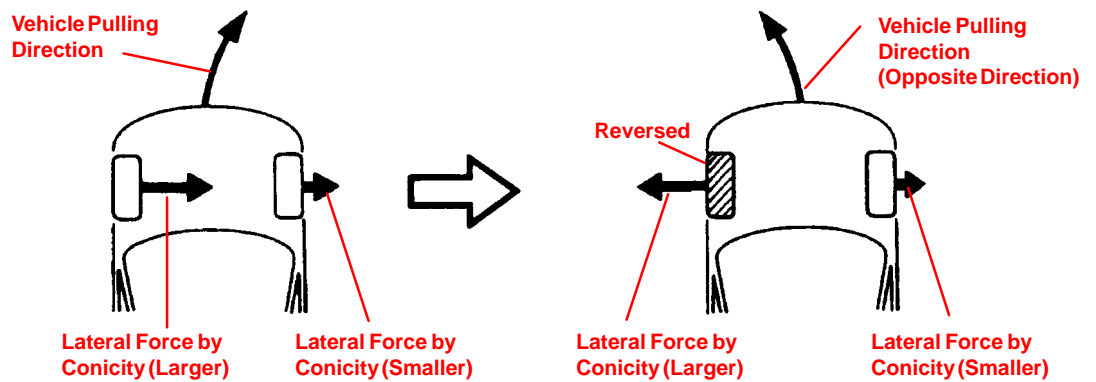

**If Vehicle Pull Is Eliminated: Repair Is Now Complete.**

The lateral force generated by the left and right front tires is virtually the same, so the lateral force is neutralized and the vehicle travels straight ahead. The repair operation is now completed.

**STEP 2:**

Rotate the **larger** lateral force front tire with the rear tire and check the change in the vehicle pulling.

**NOTE:**

By shifting the front tire with the larger lateral force to the rear, the vehicle pulling level is usually reduced.

**If Vehicle Is Still Pulling: Go to STEP 3.**

**If Vehicle Pull Is Eliminated: Repair Is Now Complete.**

**Repair Procedures**  
(Continued)

**STEP 3:**  
Adjust cross camber to eliminate vehicle pulling.

**HINT:**  
If the tires are placed in the positions they were in during tire rotation when the least amount of vehicle pulling occurred, wheel alignment can be performed with a minimal amount of adjustment.

WHEN VEHICLE PULLS TO LEFT	WHEN VEHICLE PULLS TO RIGHT
Increase right front camber and decrease left front camber until vehicle pulling is eliminated	Increase left front camber and decrease right front camber until vehicle pulling is eliminated

**NOTE:**

- Keep the cross camber within 1° or less.
- Keep the camber of each wheel within specifications (+/-45' of center value).
- If adjustment exceeds the specifications, uneven tire wear will result.

**5. Camber Adjustment Method**

**NOTE:**  
After the camber has been adjusted, inspect the toe-in.

**NOTE:**  
The method of camber adjustment differs for different models, so please refer to the repair manual of the vehicle involved. (This is a sample from the Sienna Repair Manual).

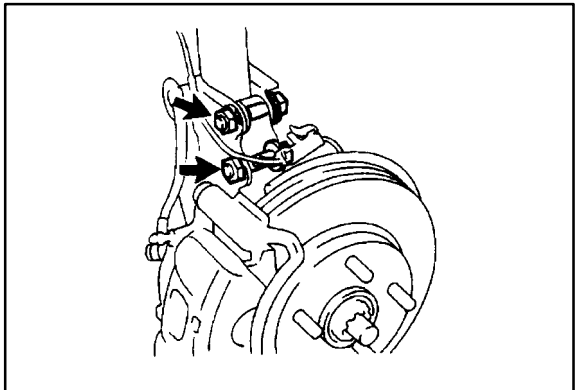



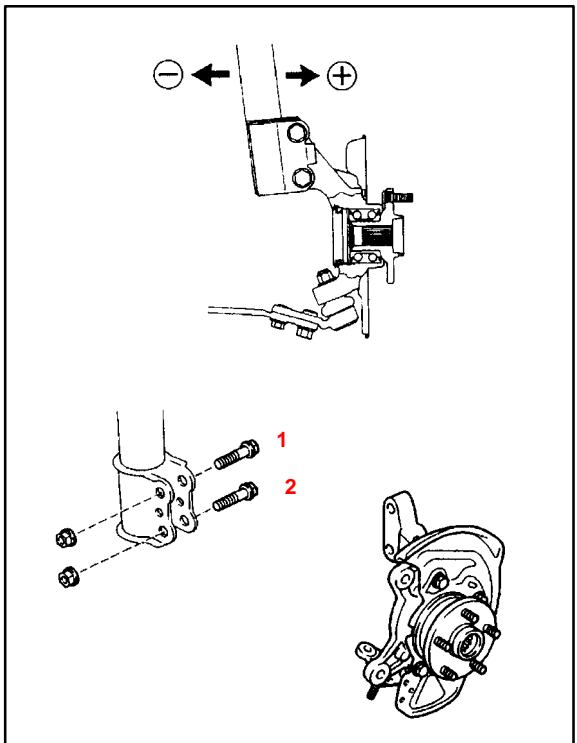

- A. Remove the front wheels and ABS speed sensor clamp.
- B. Remove the two nuts on the lower side of the shock absorber.
- C. Coat the threads of the nuts with engine oil.
- D. Temporarily install the two nuts.
- E. Adjust the camber by pushing or pulling the lower side of the shock absorber in the direction in which the camber adjustment is required.
- F. Tighten the nuts.  
**Torque: 210 N•m (2,150 kgf•cm, 155 ft•lbf)**



**Repair Procedures**  
(Continued)

- G. Install the front wheels.  
**Torque: 104 N•m (1,050 kgf•cm, 77 ft•lbf)**
- H. Check the camber.

**NOTE:**  
Adjusting value for the set bolts is 6' – 30' (0.1° – 0.5°).  
When making an adjustment of more than 45', replace the upper and lower steering knuckle set bolts with the adjusting bolts. If the camber is NOT within the specification, use the table shown to estimate how much additional camber adjustment will be required, and select the appropriate camber adjusting bolt.

Bolt	Set Bolt		Adjusting Bolt					
			1 Dot		2 Dots		3 Dots	
								
Adjusting Value	1	2	1	2	1	2	1	2
15'	●			●				
30'	●					●		
45'	●							●
1°00'			●					●
1°15'					●			●
1°30'							●	●

- I. Follow steps 5-a through 5-h again. Between steps 5-b and 5-c, exchange one or two selected bolts.

**HINT:**  
When exchanging the two bolts, exchange one bolt each time.

**If Vehicle Pull Is Eliminated: Repair Is Now Complete.**

**If Vehicle Is Still Pulling: Contact Your Regional Office for Further Assistance.**